

FEATURES

- **<-1db insertion loss to 20.3GHz**
- **<2:1VSWR to 25.3GHz**
- **21g operating spring force**
- **Z0 = 39.6Ω**
- **<31.5ps risetime**
- **72milliOhms contact resistance**
- **2 Amps max. drive current**

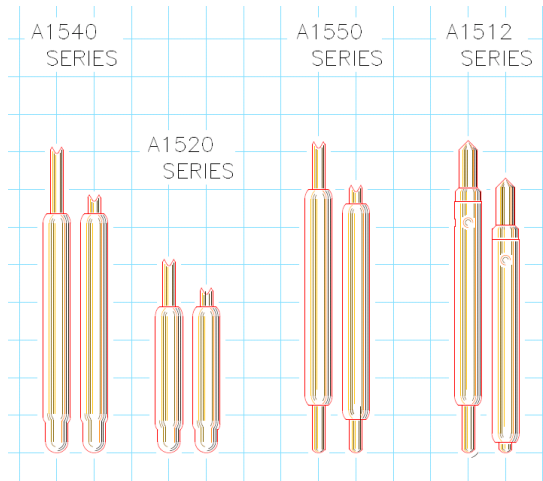

GENERAL DESCRIPTION

The A1512 spring probes from Signal Integrity are designed to meet the rigorous test requirements driven by the ultra-fast risetimes in the digital domain, and high bandwidth, high frequency RF / microwave specifications for the wireless market. Along with speed and accuracy, these probes are designed to operate at pitches to 0.4mm, specifically for the ultra fine pitch packaging these markets demand.

The ultra high bandwidth of these probes provides very low insertion loss up to 20.3GHz. These probes will provide transparent operation on Bluetooth, 802.11b and 3G wireless protocol devices as well as exceed the test probe demands of proprietary microwave communications devices and systems.

With an impulse risetime of less than 31.5ps and a propagation delay of 16.5ps, the A1512 has more than enough performance for probe applications and interconnection solutions in broadband digital. These probes are ideal for building transparent test channels or interconnection solutions that must address data communication and source synchronous memory busses. Among others, these include Infiniband, PCI-Express, Source Synchronous DDR, Rambus™, HyperTransport and 10Gb Ethernet.

SERIES A1512 MODELS: ORDERING INFORMATION

A Series 0.4mm (.0157inch) Pitch				
Model	Length Operating / Initial inches [mm]	DUT Plunger and Plating	Spring	Operating Spring Force
A1512-A1	.119 [3.02] / .131 [3.32]	Sharp point - Gold	Music wire	21 Grams
A1512-C3		4 Point Crown - Pd		
A1512-E5		Sharp point - Palladium		
A1512-S1		Kelvin – Gold		
A1512-T2		Kelvin - Palladium		

FUNCTIONAL SPECIFICATIONS

Model	A1512-C3			Units
Time Domain	Min.	Typ.	Max.	
TDT Risettime into 50Ω			30.0	ps
TDR Risettime open circuit			31.5	ps
TDR Risettime short circuit			31.5	ps
Signal Delay into 50Ω		16.5		ps
Frequency Domain				
Insertion Loss <-1db			20.3	GHz
<-3db	17.9		40.05	GHz
Return Loss, S11 <-10db	15.0		24.7	GHz
<-20db	4.6		5.0	GHz
VSWR <2:1	16.74		25.31	GHz
Equivalent Circuit Parameters				
Pin Inductance		0.66		nH
Pin Capacitance to ground, C1, C2		0.20		pF
Mutual Inductance		0.127		nH
Mutual Capacitance		0.08		pF
Transmission Line Zo		39.6		Ω
Tl		16.5		ps
DC Parameters				
Contact Resistance		72		mΩ
Maximum Rating				
Drive Current		2		A

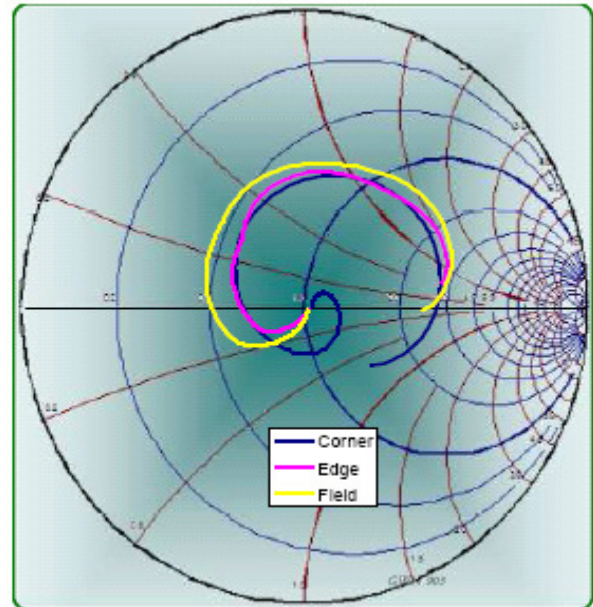

Figure 2: Measurement into 50Ω, A1512-C3

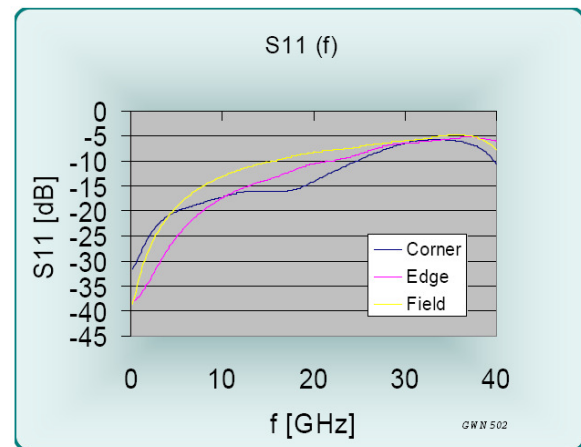

Figure 3: Return Loss, S11, A1512-C3

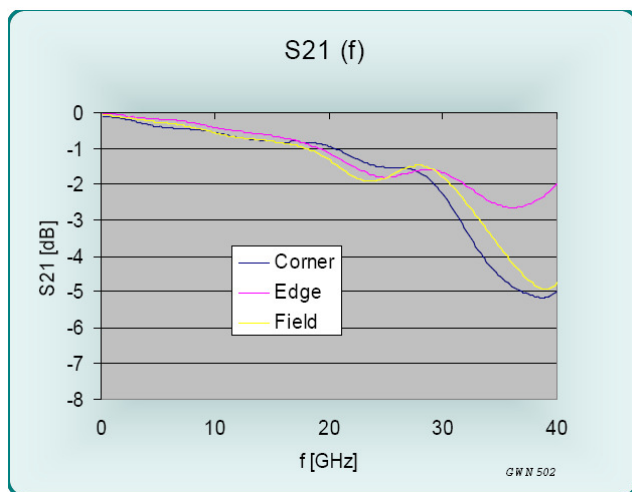

Figure 1: Insertion Loss, S21, A1512-C3

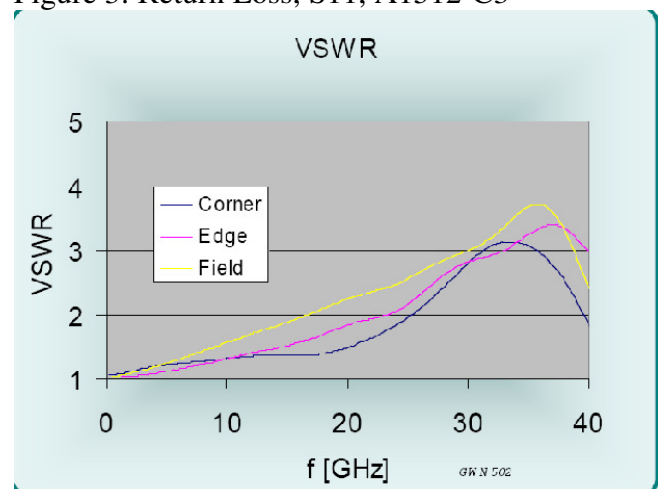

Figure 4: VSWR, A1512-C3

EQUIVALENT CIRCUITS / SPICE MODELS

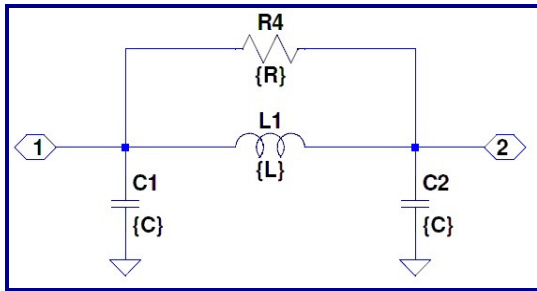

Figure 5: Lumped, Valid to <13GHz

Site	Cg = C1+C2	L1	R4
Corner	0.319 pF	0.99 nH	1000 Ω
Edge	0.380 pF	0.78 nH	1000 Ω
Field	0.406 pF	0.66 nH	1000 Ω
Diagonal	0.406 pF	0.66 nH	1000 Ω

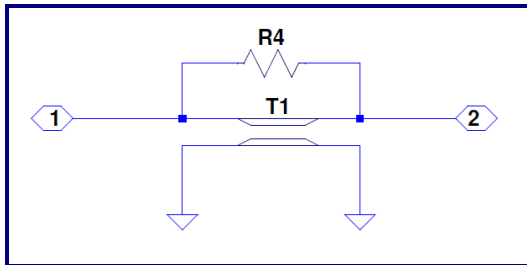

Figure 6: Distributed, Valid to >40GHz

	Zo	L	R4
Corner	55.7 Ω	17.78 ps	1000 Ω
Edge	45.2 Ω	17.17 ps	1000 Ω
Field	40.3 Ω	16.35 ps	1000 Ω

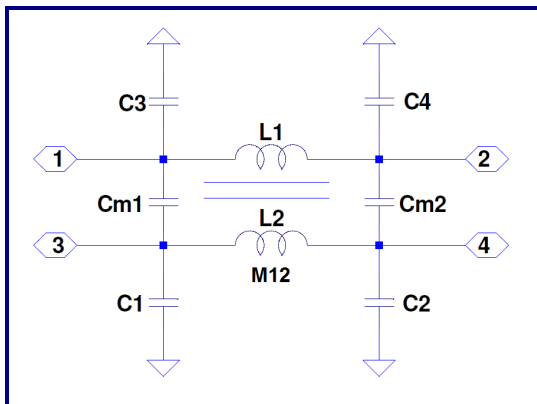

Figure 7: Lumped, Mutual Elements

Site	C1,2,3,4	Cm1,Cm2	L1,L2	M
Corner	0.160	0.049 pF	0.99	0.282 nH
Edge	0.190	0.047 pF	0.78	0.238 nH
Field	0.203	0.040 pF	0.66	0.127 nH
Diagonal	0.203	0.007 pF	0.66	0.034 nH

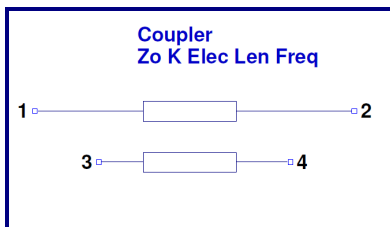
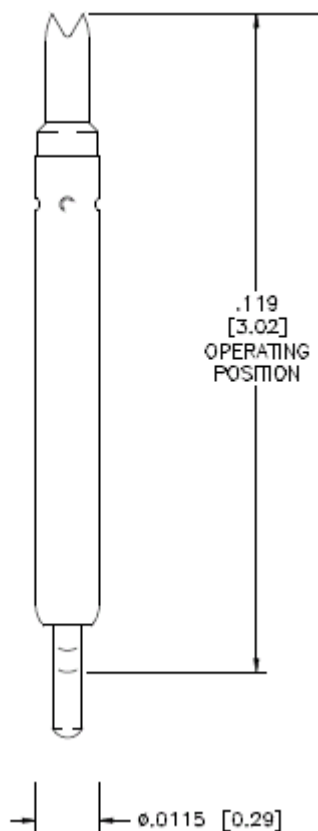

Figure 8: Transmission Line Equivalent for Crosstalk

Zo	39.6	Ohms
Lel	16.5	ps
k	0.19	
f	30.3	Ghz

MECHANICAL DIMENSIONS
 INCHES [MM]

A Series 0.4mm (.0157) pitch

Probe Series	Initial Length inch/mm		Operating Position inch/mm		Operating Spring Force	Self Inductance	Insertion Loss < -1db to	Typical Contact Resistance	Maximum Current
A1512	.131"	3.32	.119"	3.02	18-29g	0.66 nH	20.3 GHz	72 mOhms	2.0 A
A1520	.081"	2.05	.075"	1.90	20g	0.44 nH	24.1 GHz	60 mOhms	2.0 A
A1540	.126"	3.20	.114"	2.90	22-29g	0.42 nH	16.1 GHz	20 mOhms	4.3 A
A1550	.133"	3.30	.118"	3.00	20-29g	0.71 nH	18.7 GHz	85 mOhms	2.0 A
A1561	.149"	3.78	.131"	3.33	16-29g	0.67 nH	7.4 GHz	90 mOhms	1.65 A
A1562	.160"	4.06	.144"	3.66	14-30g	0.80 nH	11.6 GHz	90 mOhms	1.45 A
A1580	.210"	5.33	.192"	4.88	16-32g	1.02 nH	7.4 GHz	95 mOhms	1.55 A
A1582	.210"	5.33	.184"	4.67	16-30g	0.93 nH	9.6 GHz	100 mOhms	1.4 A
A1586	.219"	5.56	.199"	5.06	19-20g	-	-	-	-

Signal Integrity, Inc.

104 County Street, Ste. 210, Attleboro, MA 02703

 Tel: 1-508-226-6480 Fax: 1-508-226-6488 Internet: www.signalin.com

Signal Integrity makes no representation that the use of its products described herein, or the use of other technical information contained herein, will not infringe on existing or future patent rights. The descriptions contained herein do not imply the granting of licenses to make, use, or sell equipment constructed in accordance therewith. Specifications are subject to change without notice.