

## FEATURES

- <-1db insertion loss to 7.4 GHz
- <2:1 VSWR to 9.4GHz
- 22g operating spring force
- $Z_0 = 33.6\Omega$
- <40.5ps risetime
- 90 milliOhms contact resistance
- 1.65 Amps max. drive current

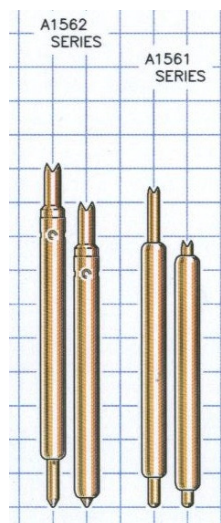

## GENERAL DESCRIPTION

The A1561 spring probe from Signal Integrity Inc. is designed to meet the rigorous test requirements driven by the ultra fast risetimes in the digital domain, and high bandwidth, high frequency RF / microwave specifications for the wireless market. Along with speed and accuracy, these probes are designed to operate at pitches to 0.4mm, specifically for the ultra fine pitch packaging these markets demand.

The ultra high bandwidth of these probes provides very low insertion loss up to 7.4GHz. These probes will provide transparent operation on Bluetooth, 802.11b and 3G wireless protocol devices as well as exceed the test probe demands of proprietary microwave communications devices and systems.

### SERIES A1561 MODELS: ORDERING INFORMATION

A Series 0.4mm (.0157) Pitch					
Model	Length Operating / Initial inches [mm]	DUT Plunger and Plating	Interface Plunger	Spring	Operating Spring Force
A1561-A1	.131 [3.33] / .149 [3.78]	4 Point Crown - Gold	Spherical	Music Wire	22 Grams
A1561-B2		4 Point Crown - Palladium		Stainless Steel	16 Grams
A1561-C3		Ogive - Gold		Music Wire	22 Grams
A1561-D4		Ogive - Palladium		Stainless Steel	18 Grams
A1561-E5		4 Point Crown - Gold			
A1561-F6		4 Point Crown - Palladium			
A1561-G7		Ogive - Gold			
A1561-H8		Ogive - Palladium		Stainless Steel	28 Grams
A1561-K2		Ogive - Gold Antidiffusion			
A1561-L3		Conic - Solid Pd Alloy			
A1561-M4		Crown - Gold Antidiffusion			
A1561-N5		Crown - Gold		Music Wire	22 Grams
A1561-P6		Ogive - Pd Antidiffusion			
A1561-Q7		Crown - Pd Antidiffusion			
A1561-T2		Ogive - Solid Pd Alloy			
A1561-U3		Ogive - Solid Pd Alloy		Ogive - Solid Pd Alloy	Music Wire
A1561-V4					

## FUNCTIONAL SPECIFICATIONS

Model	A1561-A1			Units
<b>Time Domain</b>	<b>Min.</b>	<b>Typ.</b>	<b>Max.</b>	<b>Units</b>
TDT Risetime into 50Ω			40.5	ps
TDR Risetime open circuit			52.5	ps
TDR Risetime short circuit			45.0	ps
Signal Delay into 50Ω		19.3		ps
<b>Frequency Domain</b>				
Insertion Loss <-1db	7.4			GHz
<-3db	>40.0			GHz
Return Loss, S11 <-10db	9.2			GHz
<-20db	2.8			GHz
VSWR <2:1	9.4			GHZ
<b>Equivalent Circuit Parameters</b>				
Pin Inductance		0.67		NH
Pin Capacitance to ground, C1, C2		0.24		pF
Mutual Inductance		0.129		nH
Mutual Capacitance		0.103		pF
Transmission Line Zo		33.6		Ω
Tl		19.3		ps
<b>DC Parameters</b>				
Contact Resistance		90		mΩ
<b>Maximum Rating</b>				
Drive Current		1.65		A

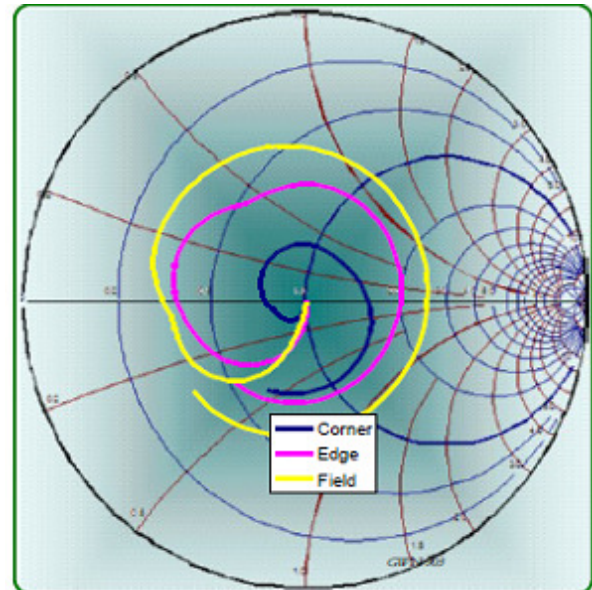

Figure 2: Measurement into 50Ω, A1561-A1

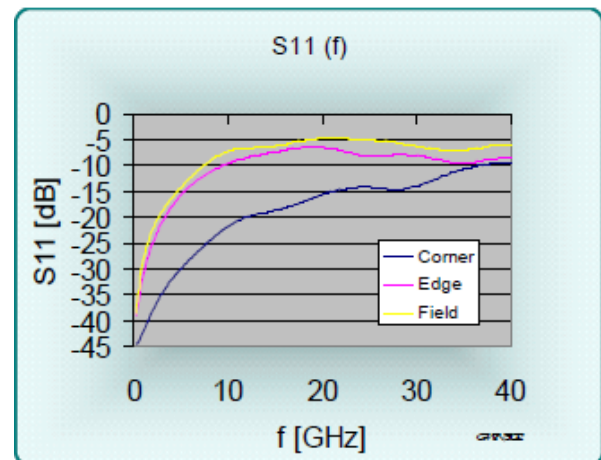

Figure 3: Return Loss, S11, A1561-A1

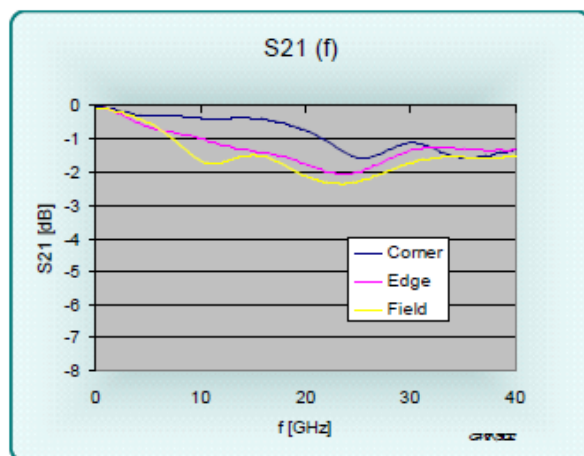

Figure 1: Insertion Loss, S21, A1561-A1

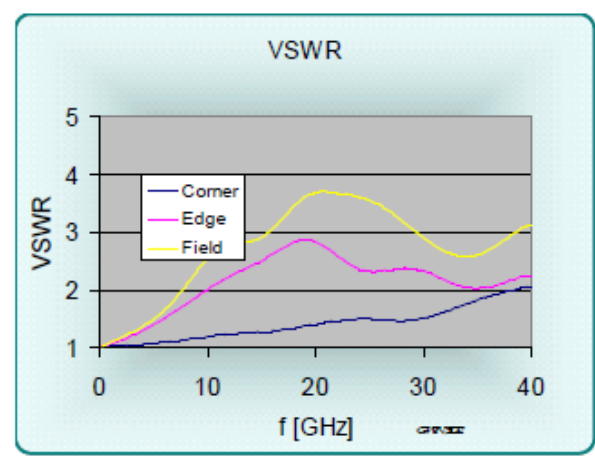

Figure 4: VSWR, A1561-A1

EQUIVALENT CIRCUITS / SPICE MODELS

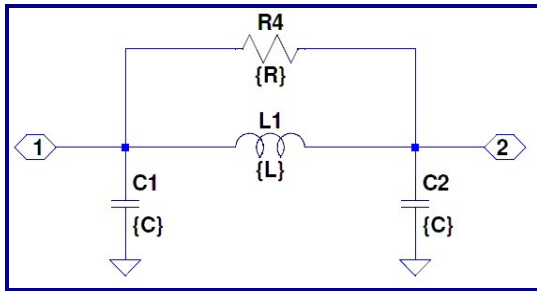

Figure 5: Pi Equivalent, Valid to 13GHz

Site	Cg = C1+C2	L1	R4
Corner	0.333 pF	0.92 nH	700 Ω
Edge	0.433 pF	0.81 nH	400 Ω
Field	0.487 pF	0.67 nH	400 Ω
Diagonal	0.487 pF	0.67 nH	400 Ω

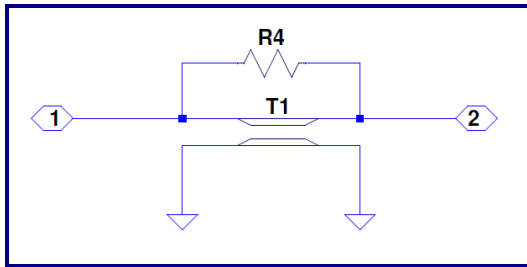

Figure 6: Transmission Line Model Valid to >40GHz

Site	Zo	L	R4
Corner	52.6 Ω	17.53 ps	1000 Ω
Edge	43.2 Ω	18.71 ps	600 Ω
Field	37.0 Ω	18.04 ps	600 Ω

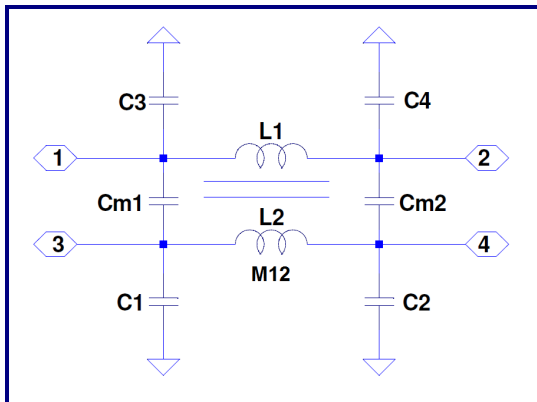

Figure 7: Lumped, Mutual Elements

Site	C1,2,3,4	Cm1,Cm2	L1,L2	M
Corner	0.167	0.060 pF	0.92	0.300 nH
Edge	0.217	0.050 pF	0.81	0.211 nH
Field	0.244	0.052 pF	0.67	0.129 nH
Diagonal	0.244	0.008 pF	0.67	0.079 nH

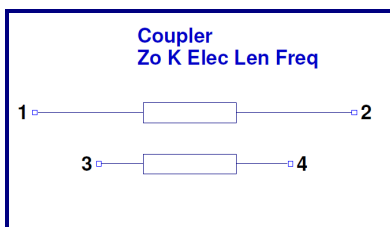
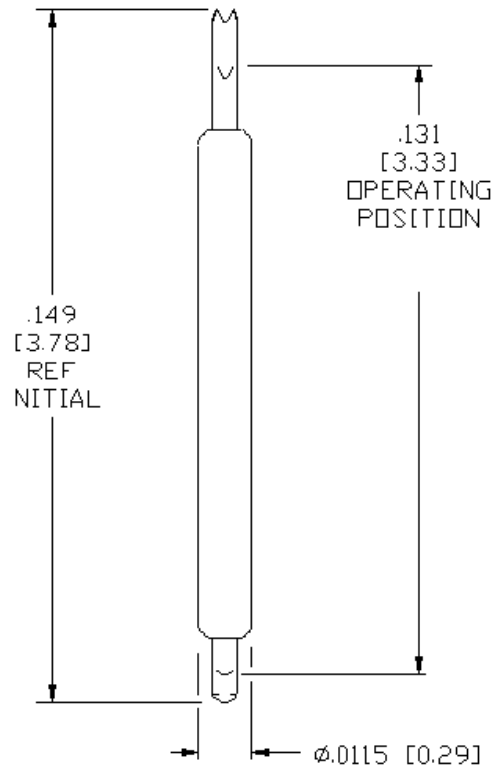

Figure 8: Transmission Line Equivalent for Crosstalk

Z0	L1	k	f
33.6 Ω	19.3 ps	0.19	23.8 GHz

**A Series 0.4mm (.0157) pitch**

Probe Series	Initial Length inch/mm		Operating Position inch/mm		Operating Spring Force	Self Inductance	Insertion Loss < -1db to	Typical Contact Resistance	Maximum Current
<a href="#">A1512</a>	.131"	3.32	.119"	3.02	18-29g	0.66 nH	20.3 GHz	72 mOhms	2.0 A
<a href="#">A1520</a>	.081"	2.05	.075"	1.90	20g	0.44 nH	24.1 GHz	60 mOhms	2.0 A
<a href="#">A1540</a>	.126"	3.20	.114"	2.90	22-29g	0.42 nH	16.1 GHz	20 mOhms	4.3 A
<a href="#">A1550</a>	.133"	3.30	.118"	3.00	20-29g	0.71 nH	18.7 GHz	85 mOhms	2.0 A
<a href="#">A1561</a>	.149"	3.78	.131"	3.33	16-29g	0.67 nH	7.4 GHz	90 mOhms	1.65 A
<a href="#">A1562</a>	.160"	4.06	.144"	3.66	14-30g	0.80 nH	11.6 GHz	90 mOhms	1.45 A
<a href="#">A1580</a>	.210"	5.33	.192"	4.88	16-32g	1.02 nH	7.4 GHz	95 mOhms	1.55 A
<a href="#">A1582</a>	.210"	5.33	.184"	4.67	16-30g	0.93 nH	9.6 GHz	100 mOhms	1.4 A
<a href="#">A1586</a>	.219"	5.56	.199"	5.06	19-20g	-	-	-	-

**MECHANICAL DIMENSIONS  
INCHES [MM]**

**Signal Integrity, Inc.**  
 104 County Street, Ste. 210, Attleboro, MA 02703  
 Tel: 1-508-226-6480 Fax: 1-508-226-6488 Internet: [www.signalin.com](http://www.signalin.com)

Signal Integrity makes no representation that the use of its products described herein, or the use of other technical information contained herein, will not infringe on existing or future patent rights. The descriptions contained herein do not imply the granting of licenses to make, use, or sell equipment constructed in accordance therewith. Specifications are subject to change without notice.