

FEATURES

- <-1db insertion loss to 9.6 GHz
- <2:1 VSWR to 30.9 GHz
- 16 – 30 gram operating spring force
- $Z_0 = 32.2 \Omega$
- <40.5 ps risetime
- 100 milliOhms contact resistance
- 1.4 Amps max. drive current

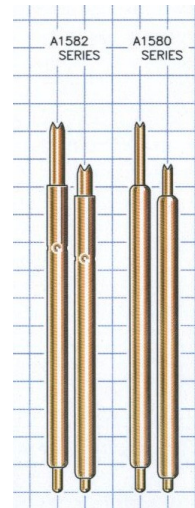

GENERAL DESCRIPTION

The A1582 spring probe from Signal Integrity Inc. is designed to meet the rigorous test requirements driven by the ultra fast risetimes in the digital domain, and high bandwidth, high frequency RF / microwave specifications for the wireless market. Along with speed and accuracy, these probes are designed to operate at pitches to 0.4mm, specifically for the ultra fine pitch packaging these markets demand.

The ultra high bandwidth of these probes provides very low insertion loss up to 9.6 GHz. These probes will provide transparent operation on Bluetooth, 802.11b and 3G wireless protocol devices as well as exceed the test probe demands of proprietary microwave communications devices and systems.

With an impulse risetime of less than 40.5 ps and a propagation delay of 26.7 ps, the A1582 has more than enough performance for probe applications and interconnection solutions in broadband digital. These probes are ideal for building transparent test channels or interconnection solutions that must address datacom and source synchronous memory busses. Among others, these include Infiniband, PCI-Express, Source Synchronous DDR, Rambus[™], HyperTransport and 10Gb Ethernet.

SERIES A1582 MODELS: ORDERING INFORMATION

A Series 0.4mm (.0157) Pitch					
Model	Length Operating / Initial inches [mm]	DUT Plunger and Plating	Interface Plunger	Spring	Operating Spring Force
A1582-A1	.192 [4.88] / .210 [5.33]	Crown - Gold	Spherical	Music wire	30 Grams
A1582-N5	.184 [4.67] / .210 [5.33]	Ogive - Gold		Stainless Steel	16 Grams
A1582-P6				21 Grams	
A1582-Q7				Music wire	30 Grams

FUNCTIONAL SPECIFICATIONS

Model	A1582-A1			
Time Domain	Min.	Typ.	Max.	Units
TDT Risetime into 50Ω	31.5		40.5	ps
TDR Risetime open circuit	33.0		56.0	ps
TDR Risetime short circuit	28.5		99.0	ps
Signal Delay into 50Ω		25.5		ps
Frequency Domain				
Insertion Loss <-1db	9.6		25.9	GHz
<-3db	37.5	>40.0		GHz
Return Loss, S11 <-10db	30.5		33.9	GHz
<-20db	1.4		7.8	GHz
VSWR <2:1	30.9			GHZ
Equivalent Circuit Parameters				
Pin Inductance		0.93		nH
Pin Capacitance to ground, C1, C2		0.709		pF
Mutual Inductance		0.93		nH
Mutual Capacitance		0.030		pF
Transmission Line Zo		32.2		Ω
Tl		25.5		ps
DC Parameters				
Contact Resistance		100		mΩ
Maximum Rating				
Drive Current		1.4		A

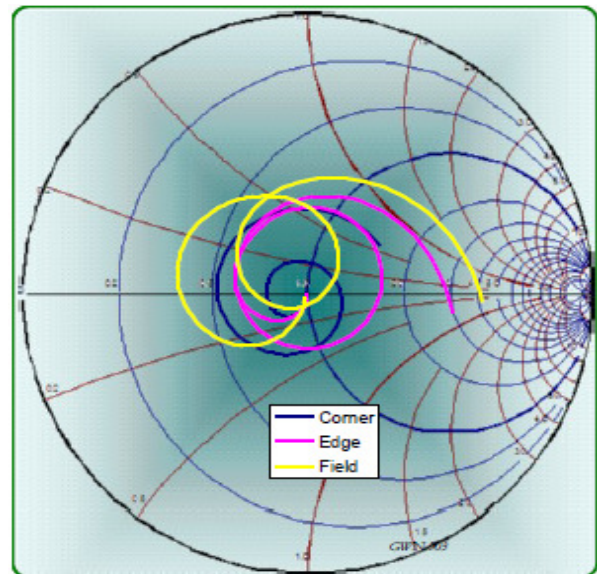

Figure 2: Measurement into 50Ω, A1582-A1

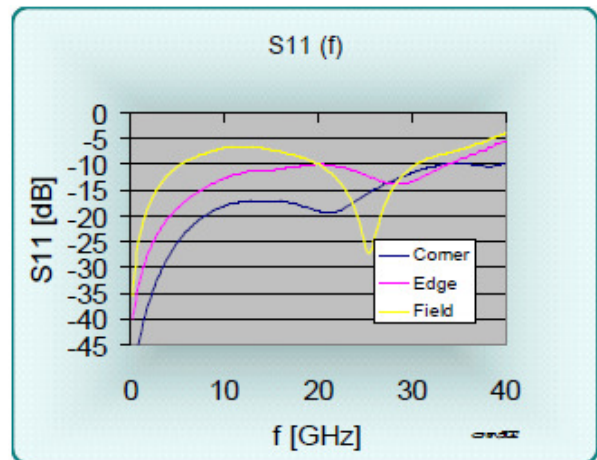

Figure 3: Return Loss, S11, A1582-A1

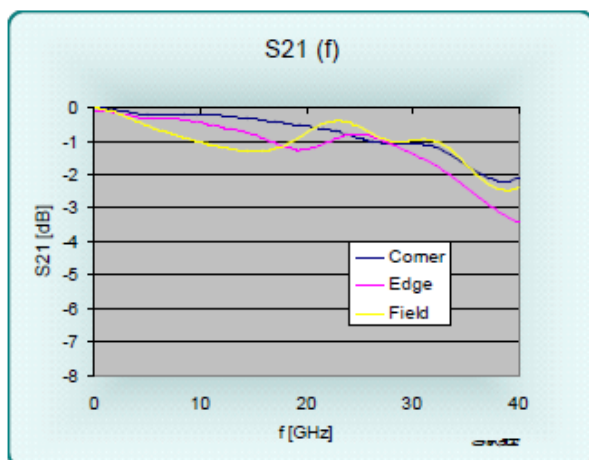

Figure 1: Insertion Loss, S21, A1582-A1

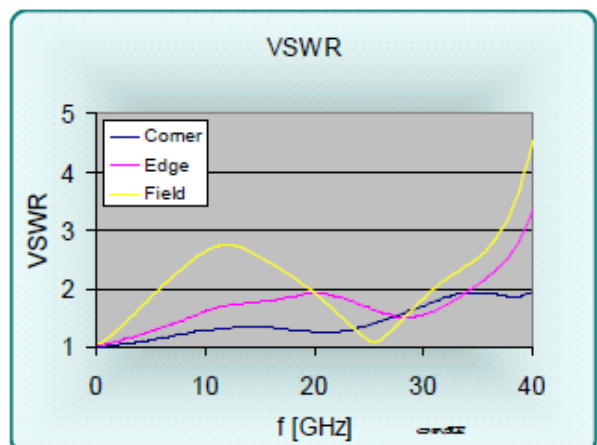

Figure 4: VSWR, A1582-A1

EQUIVALENT CIRCUITS / SPICE MODELS

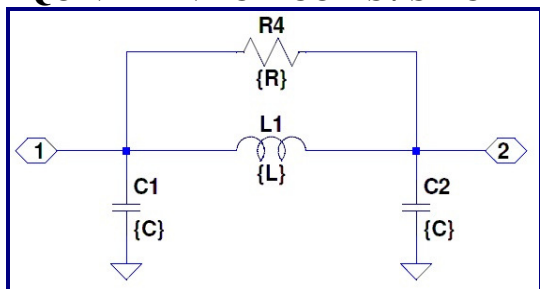

Figure 5: Pi Equivalent, Valid to 9GHz

Site	C1 + C2	L1	R4
Corner	0.515 pf	1.42 nH	700 Ohms
Edge	0.584 pf	1.27 nH	600 Ohms
Field	0.709 pf	0.93 nH	400 Ohms
Diagonal	0.709 pf	0.93 nH	400 Ohms

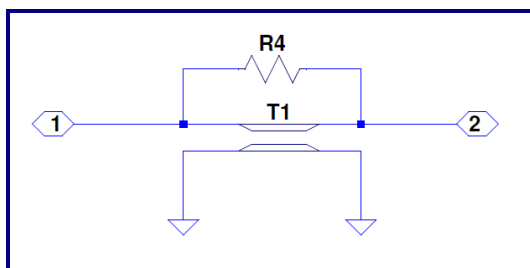

Figure 6: Transmission Line Model
Valid to >40GHz

Site	Zo	L	R4
Corner	52.5 Ω	27.0 ps	3000 Ω
Edge	46.6 Ω	27.2 ps	1200 Ω
Field	36.1 Ω	25.6 ps	900 Ω

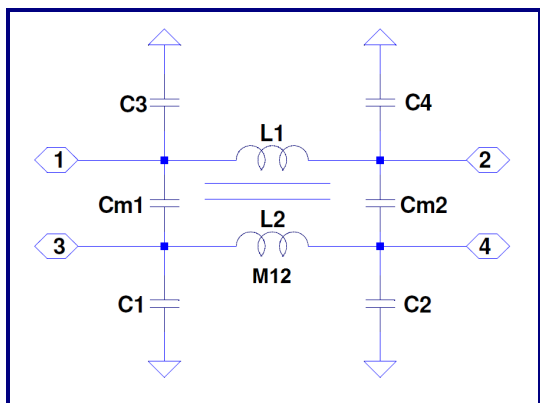

Figure 7: Lumped, Mutual Elements

Site	C1,2,3,4	Cm1,Cm2	L1,L2	M
Corner	0.257	0.092 pF	1.42	0.398 nH
Edge	0.292	0.077 pF	1.27	0.280 nH
Field	0.354	0.066 pF	0.93	0.199 nH
Diagonal	0.354	0.030 pF	0.93	0.118 nH

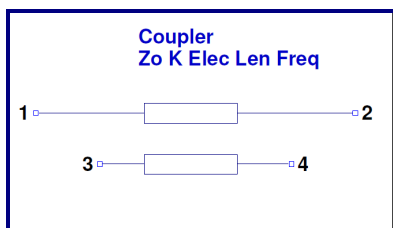
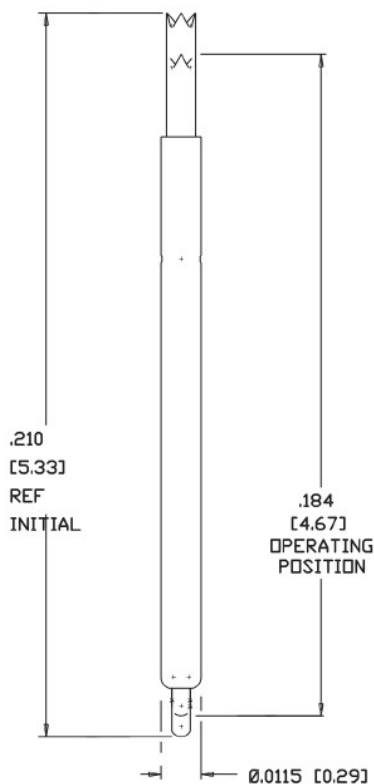

Figure 8: Transmission Line
Equivalent for Crosstalk

Z0	L1	k	f
32.2 Ω	25.5 ps	0.21	18.5 GHz

A Series 0.4mm (.0157) pitch

Probe Series	Initial Length		Operating Position		Operating Spring Force	Self Inductance	Insertion Loss < -1db to	Typical Contact Resistance	Maximum Current
	inch	mm	inch	mm					
A1512	.131"	3.32	.119"	3.02	18-29g	0.66 nH	20.3 GHz	72 mOhms	2.0 A
A1520	.081"	2.05	.075"	1.90	20g	0.44 nH	24.1 GHz	60 mOhms	2.0 A
A1540	.126"	3.20	.114"	2.90	22-29g	0.42 nH	16.1 GHz	20 mOhms	4.3 A
A1550	.133"	3.30	.118"	3.00	20-29g	0.71 nH	18.7 GHz	85 mOhms	2.0 A
A1561	.149"	3.78	.131"	3.33	16-29g	0.67 nH	7.4GHz	90 mOhms	1.65 A
A1562	.160"	4.06	.144"	3.66	14-30g	0.80 nH	11.6 GHz	90 mOhms	1.45 A
A1580	.210"	5.33	.192"	4.88	16-32g	1.02 nH	7.4 GHz	95 mOhms	1.55 A
A1582	.210"	5.33	.184"	4.67	16-30g	0.93 nH	9.6 GHz	100 mOhms	1.4 A
A1586	.219"	5.56	.199"	5.06	19-20g	-	-	-	-

MECHANICAL DIMENSIONS
 INCHES [MM]

Signal Integrity, Inc.

104 County Street, Ste. 210, Attleboro, MA 02703

 Tel: 1-508-226-6480 Fax: 1-508-226-6488 Internet: www.signalin.com

Signal Integrity makes no representation that the use of its products described herein, or the use of other technical information contained herein, will not infringe on existing or future patent rights. The descriptions contained herein do not imply the granting of licenses to make, use, or sell equipment constructed in accordance therewith. Specifications are subject to change without notice.