

FEATURES

- **Conic / Kelvin Probe Options**
- **<-1db insertion loss 37.1 GHz**
- **<2:1 VSWR to 38.5 GHz**
- **18-20g operating spring force**
- **Z0 = 54.3 Ω**
- **<30 ps risetime**
- **100 milliohms**
- **1.32 Amps max drive current**



GENERAL DESCRIPTION

The AA917 series spring probes from Signal Integrity Inc. are designed to meet the rigorous test probe bandwidth of the wireless and RF test markets as well as very fast rise times in test applications for telecommunication and broadband data communications system-on-a-chip devices. The risetime requirements for these devices are usually well below 150 picoseconds. Along with speed and accuracy, these probes are designed for testing ultra-fine pitch to 0.3mm, well suited to the packaging constraints driven by the consumer wireless market.

The high bandwidth of these probes provides very low insertion loss up to 37.1 GHz. These probes will provide transparent operation on Bluetooth, 802.11b and 3G wireless protocol devices as well as exceed the test probe demands of proprietary microwave communications devices and systems.

With an impulse risetime of less than 30 ps and a propagation delay of 23.4ps, the AC performance of the AA917 probe is transparent for test applications and interconnections solutions that operate in high speed CMOS, SiGe and GaAs technologies.

SERIES AA917 MODELS: ORDERING INFORMATION

AA Series 0.3mm (.0118) Pitch				
Model	Length Operating / Initial inches [mm]	DUT Type / Plating	Spring	Operating Spring Force
AA917-A1	.199 [5.05] / .219 [5.57]	Conic - Gold	Music Wire	20 Grams
AA917-B2		Kelvin - Gold		
AA917-C3		Conic - Gold	Stainless Steel	18 Grams
AA917-D4		Kelvin - Gold		
AA917-E5		Conic Indent - Gold		
AA917-F6		Kelvin - Gold A.D.		
AA917-G7		Crown - Gold		
AA917-H8		Reduced Crown - Gold		
AA917-J9		Reduced Crown - Gold	Music Wire	20 Grams

FUNCTIONAL SPECIFICATIONS

Model	AA917-E5			Units
	Corner	Edge	Field	
TDT Risetime thru 50Ω	28.5	28.5	30	ps
TDR Risetime open circuit	30	37.5	40.5	ps
TDR Risetime short circuit	108	28.5	30	ps
Signal Delay into 50Ω	23.4	22.9	21.6	ps
Insertion Loss <-1db	35.3	36.5	37.1	GHz
Insertion Loss <-3db	38.7	39.5	>40	GHz
VSWR <2:1	37.3	37.3	38.5	GHz

Equivalent Circuit Parameters

	Min.	Typ.	Max.	Units
Pin Inductance		1.0		nH
Pin Capacitance		.444		pF
Mutual Inductance		.192		nH
Mutual Capacitance		.090		pF
Transmission Line				
Zo		54.3		Ω
Tl		11.1		ps

MAXIMUM DC CURRENT

DUTY CYCLE	DC	50%	25%	10%	1%
AMPS	1.32	1.67	1.85	2.047	2.17

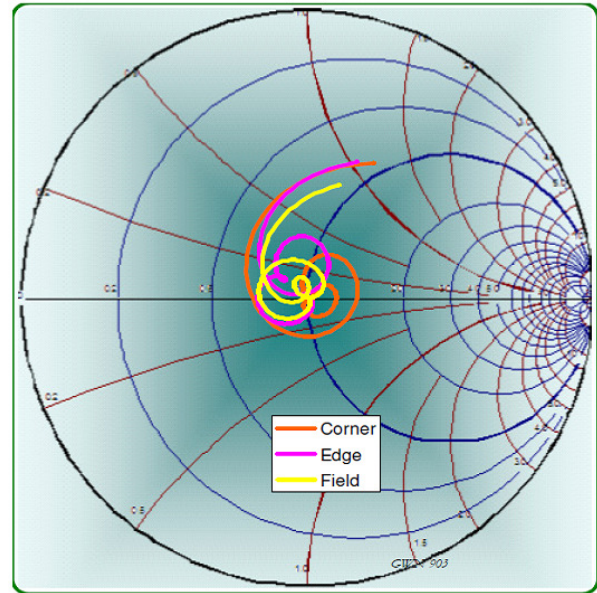

Figure 2: Measurement into 50Ω, AA917-E5

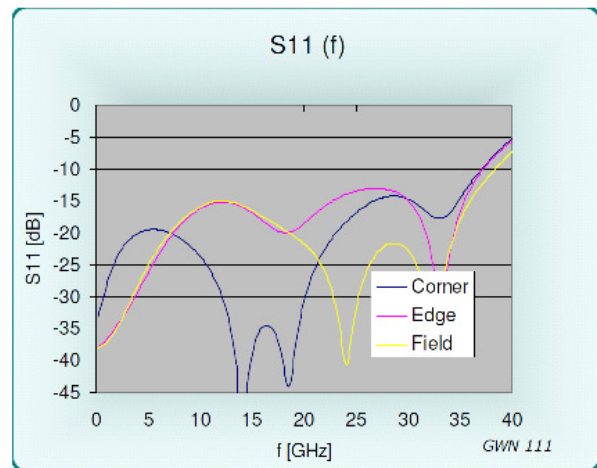

Figure 3: Return Loss, S11, AA917-E5

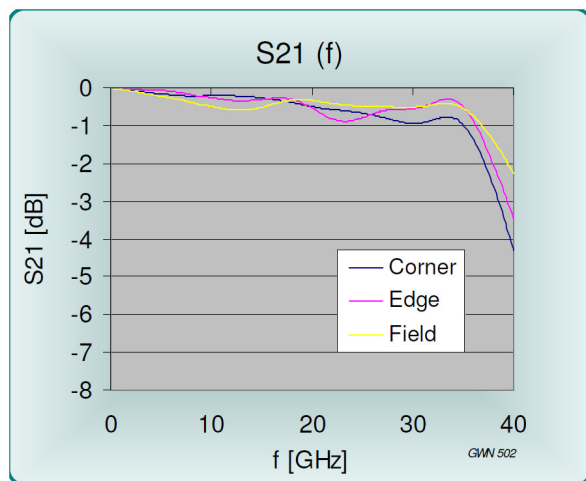

Figure 1: Insertion Loss, S21, AA917-E5

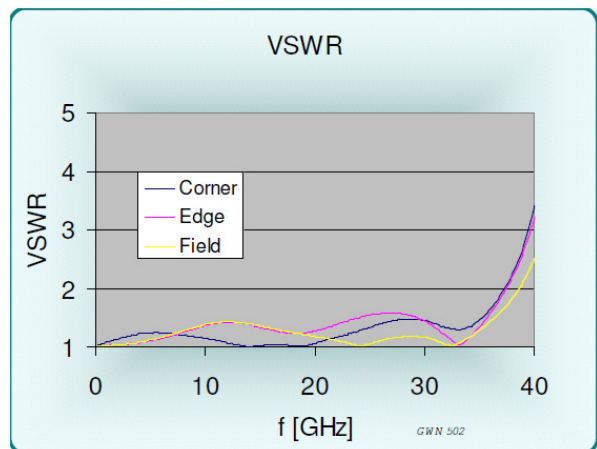

Figure 4: VSWR, AA917-E5

EQUIVALENT CIRCUITS / SPICE MODELS

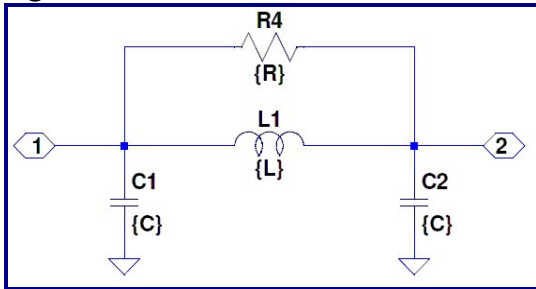

Figure 5: Pi Equivalent, Valid to 11 GHz

Site	Cg = C1+C2	L1	R4
Corner	0.354 pF	1.29 nH	2000 Ω
Edge	0.436 pF	1.03 nH	1500 Ω
Field	0.444 pF	1.00 nH	1000 Ω
Diagonal	0.444 pF	1.0 0nH	1000 Ω

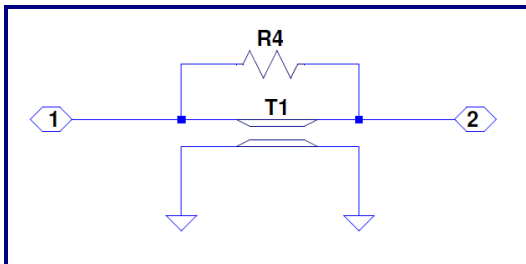

Figure 6: Transmission Line Model Valid <14.9 GHz

	Zo	L	R4
Corner	60.3 Ω	21.33 ps	2000 Ω
Edge	48.67 Ω	21.15 ps	2000 Ω
Field	47.5 Ω	21.09 ps	2000 Ω

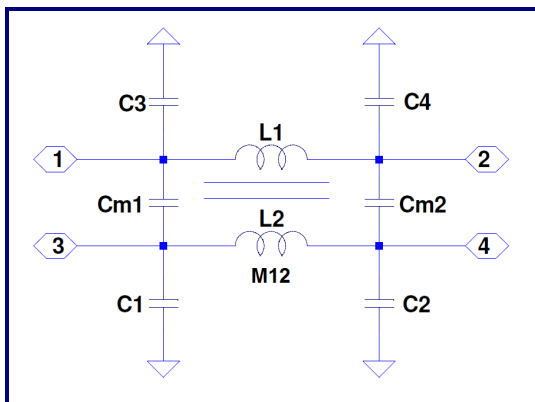

Figure 7: Lumped, Mutual Elements

Site	C1,2,3,4	Cm1,Cm2	L1,L2	M
Corner	0.177	0.060 pF	1.29	0.603 nH
Edge	0.218	0.060 pF	1.03	0.374 nH
Field	0.222	0.045 pF	1.00	0.192 nH
Diagonal	0.222	0.008 pF	1.00	0.083 nH

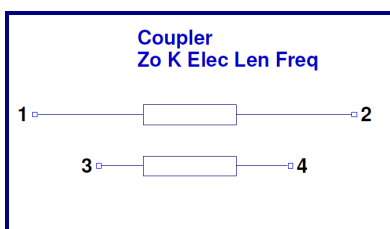
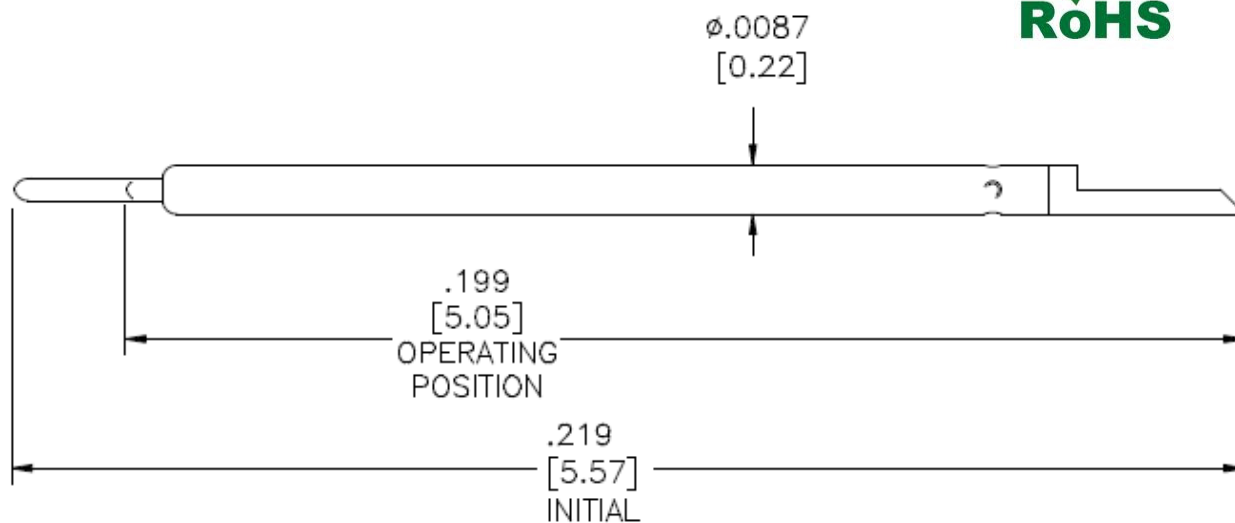

Figure 8: Transmission Line Equivalent for Crosstalk

Z0	54.3	Ohms
Lel	11.1	ps
k	0.19	
f	23.7	Ghz

AA Series 0.3mm (.0118) pitch									
Probe Series	Initial Length inch/mm		Operating Position inch/mm		Operating Spring Force	Self Inductance	Insertion Loss < -1db to	Typical Contact Resistance	Maximum Current
AA905	.100	2.54	.086	2.18	20 grams	0.54 nH	>40 GHz	110 mOhms	1.43 A
AA909	.215	5.45	.193	4.90	12-17 grams	1.54 nH	12.0 GHz	72 mOhms	0.95 A
AA917	.219	5.57	.199	5.05	18-20 grams	1.0 nH	37.1 GHz	100 mOhms	1.32 A

MECHANICAL DIMENSIONS
INCHES [MM]



Signal Integrity, Inc.
 104 County Street, Ste. 210, Attleboro, MA 02703
 Tel: 1-508-226-6480 Fax: 1-508-226-6488 Internet: www.signalin.com

Signal Integrity makes no representation that the use of its products described herein, or the use of other technical information contained herein, will not infringe on existing or future patent rights. The descriptions contained herein do not imply the granting of licenses to make, use, or sell equipment constructed in accordance therewith. Specifications are subject to change without notice.