

FEATURES

0.8mm (.0315inch) Pitch

- <-1db insertion loss to 19.5 GHz
- <2:1VSWR to 18.9 GHz
- 38g operating spring force
- $Z_0 = 42.2 \Omega$
- 19.7ps risetime
- 30 milliOhms contact resistance
- 3.0 Amps max. drive current

1.0mm (.0394inch) Pitch

- <-1db insertion loss to 24.3 GHz
- <2:1VSWR to 18.7 GHz
- 38g operating spring force
- $Z_0 = 42.8 \Omega$
- 16.8ps risetime
- 30 milliOhms contact resistance
- 3.0 Amps max. drive current

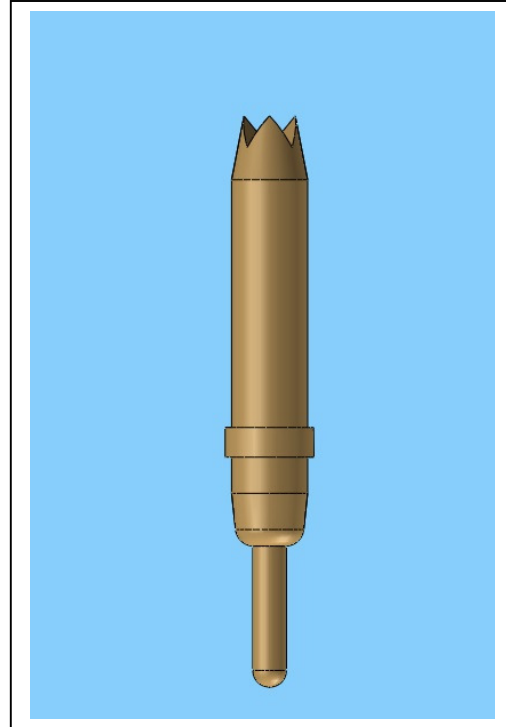

GENERAL DESCRIPTION

The D4595 spring probe from Signal Integrity Inc. is designed to meet the rigorous test requirements driven by the ultra fast risetimes in the digital domain, and high bandwidth, high frequency RF / microwave specifications for the wireless market. Along with speed and accuracy, these probes are designed to operate at pitches to 0.8mm / 1.0mm, specifically for the fine pitch packaging these markets demand.

The ultra high bandwidth of these probes provides very low insertion loss up to 19.5GHz @ Pitch 0.8mm / 24.3GHz @ Pitch 1.0mm. These probes will provide transparent operation on Bluetooth, 802.11b and 3G wireless protocol devices as well as exceed the test probe demands of proprietary microwave communications devices and systems.

With an impulse risetime of less than 31.5ps / 30.0ps and a propagation delay of 19.7ps / 16.8ps, the D4595 has more than enough performance for probe applications and interconnection solutions in broadband digital. These probes are ideal for building transparent test channels or interconnection solutions that must address data communication and source synchronous memory busses. Among others, these include Infiniband, PCI-Express, Source Synchronous DDR, Rambus[™], HyperTransport and 10Gb Ethernet.

D4595 MODELS: ORDERING INFORMATION

D4595 Series				
Model	Length Operating / Initial inches [mm]	DUT Plunger and Plating	Spring	Operating Spring Force
D4595-A1	.128 [3.25] / .1541 [3.91]	4 Point Crown - Gold	Stainless Steel	38 Grams
D4595-B2		4 Point Crown - Gold Anti-Diffusion Coating		

FUNCTIONAL SPECIFICATIONS

Model	D4595-B2 (Pitch 0.8mm)			D4595-B2 (Pitch 1.0mm)			Units
	Min.	Typ.	Max.	Min.	Typ.	Max.	
Time Domain							
TDT Risetime into 50Ω			31.5			30.0	ps
TDR Risetime open circuit			34.5			30.0	ps
TDR Risetime short circuit			30.0			34.5	ps
Signal Delay into 50Ω		17.3			17.2		ps
Frequency Domain							
Insertion Loss <-1.0db	19.5			24.3			GHz
<-3.0db	>40			38.5			GHz
Return Loss, S11 <-10db	29			30			GHz
<-20db	14.9			8.4			GHz
VSWR <2:1	18.9			18.7			GHz
Equivalent Circuit Parameters							
Pin Inductance		0.82			0.98		nH
Pin Capacitance to ground		0.17			0.15		pF
Mutual Inductance		0.069			0.105		nH
Mutual Capacitance		0.03			0.02		pF
Transmission Line Zo		42.2			42.8		Ω
Tl		19.7			16.8		ps
DC Parameters							
Contact Resistance	30						mΩ
Maximum Rating							
Drive Current	3.0						A

0.8mm (.0315inch) Pitch

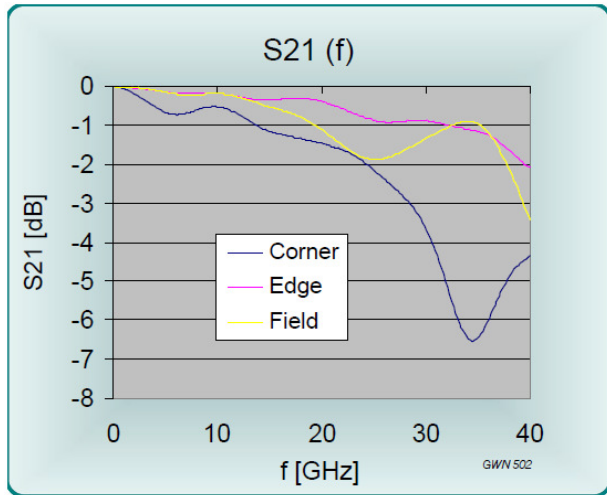

Figure 1: Insertion Loss, S21, D4595-B2

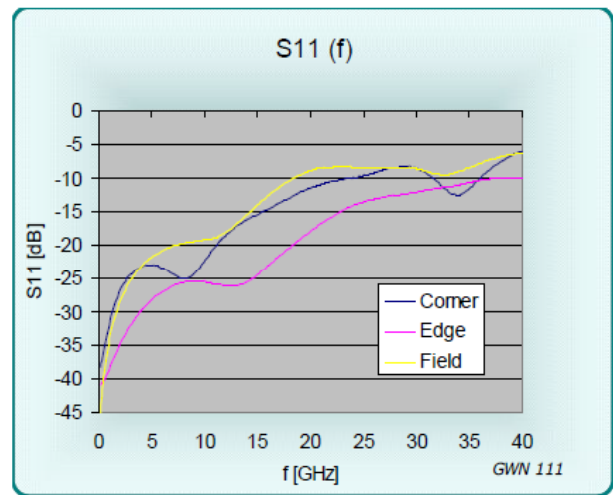

Figure 3: Return Loss, S11, D4595-B2

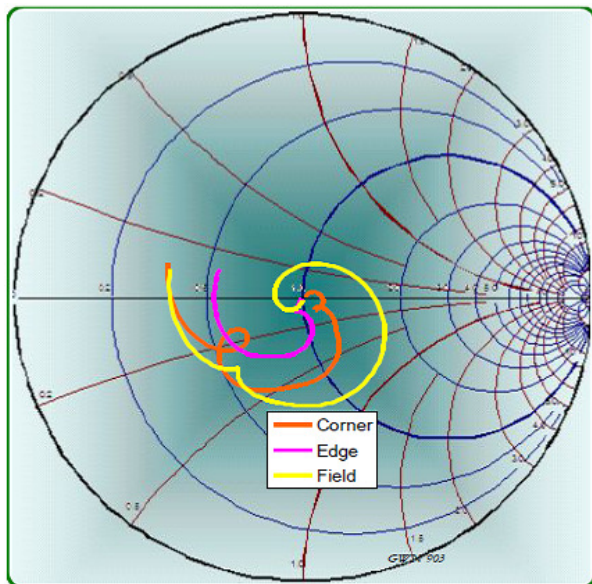

Figure 2: Measurement into 50Ω, D4595-B2

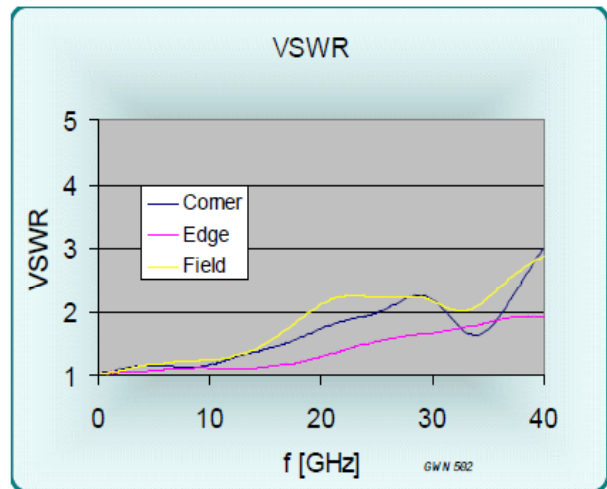

Figure 4: VSWR, D4595-B2

0.8mm (.0315inch) Pitch
EQUIVALENT CIRCUITS / SPICE MODELS

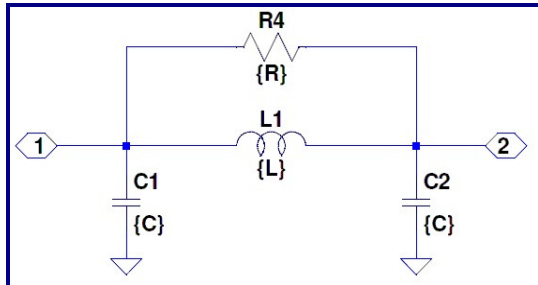

Figure 5: Lumped, Valid to <7GHz

Site	$C_g = C1+C2$	L1	R4
Corner	0.306 pF	1.22 nH	300 Ω
Edge	0.303 pF	0.93 nH	500 Ω
Field	0.347 pF	0.82 nH	600 Ω
Diagonal	0.347 pF	0.82 nH	600 Ω

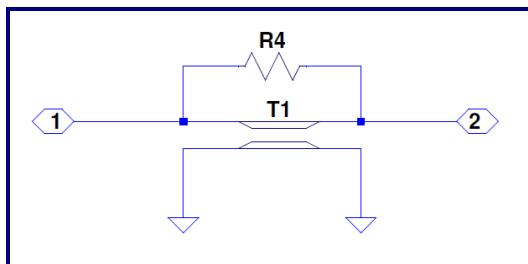

Figure 6: Transmission Line

	Z_o	L	R4
Corner	63.1 Ω	19.29 ps	1000 Ω
Edge	54.5 Ω	17.06 ps	2000 Ω
Field	48.6 Ω	16.85 ps	1000 Ω

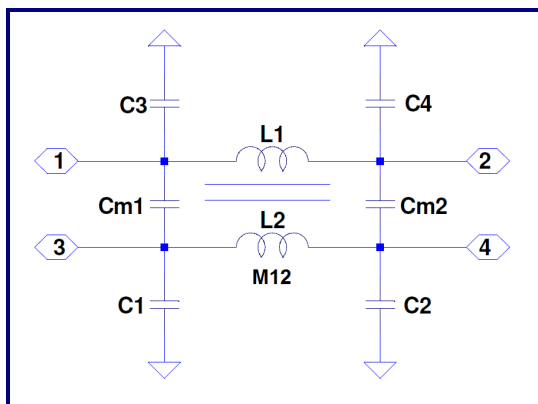

Figure 7: Lumped, Mutual Elements

Site	C1,2,3,4	Cm1,Cm2	L1,L2	M
Corner	0.153	0.045 pF	1.22	0.328 nH
Edge	0.156	0.037 pF	0.93	0.219 nH
Field	0.173	0.033 pF	0.82	0.144 nH
Diagonal	0.173	0.008 pF	0.82	0.069 nH

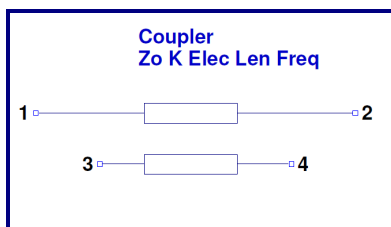

Figure 8: Transmission Line for Crosstalk

Z0	42.2	Ohms
Lel	19.7	ps
k	0.18	
f	29.7	Ghz

1.0mm (.0394inch) Pitch

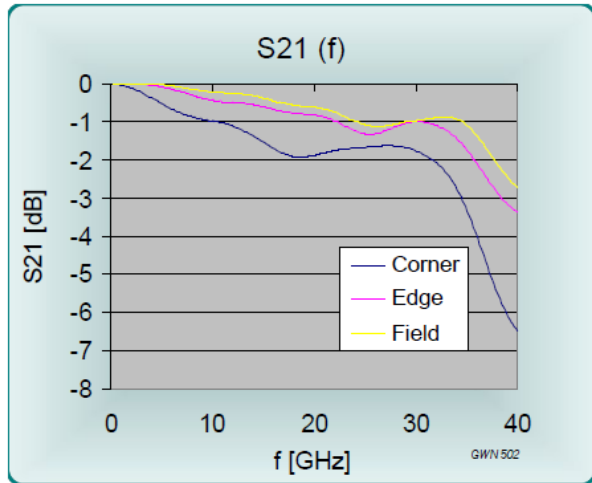

Figure 1: Insertion Loss, S21, D4595-B2

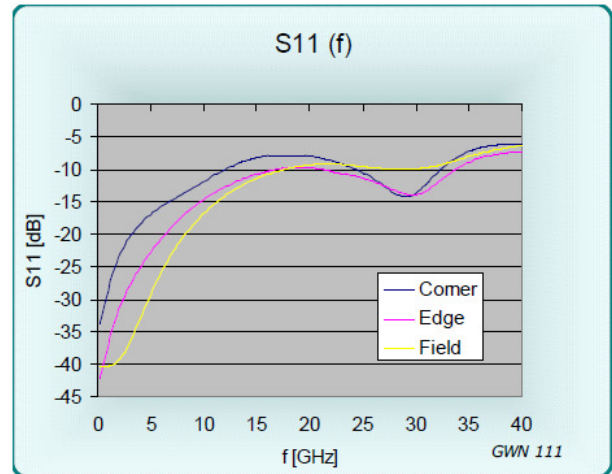

Figure 3: Return Loss, S11, D4595-B2

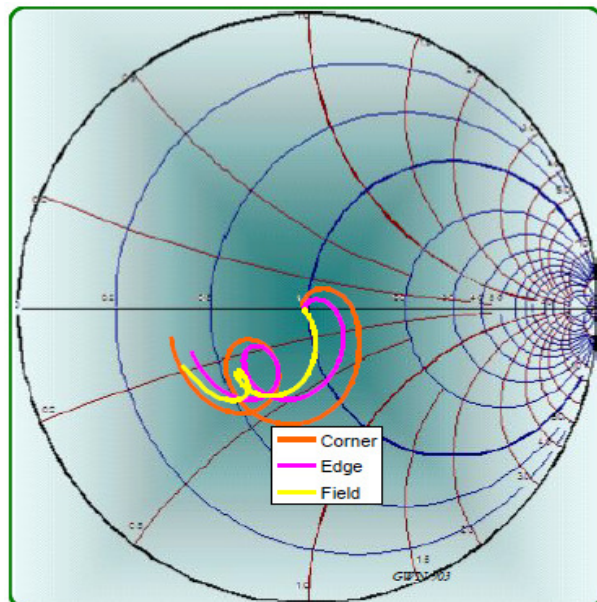

Figure 2: Measurement into 50Ω, D4595-B2

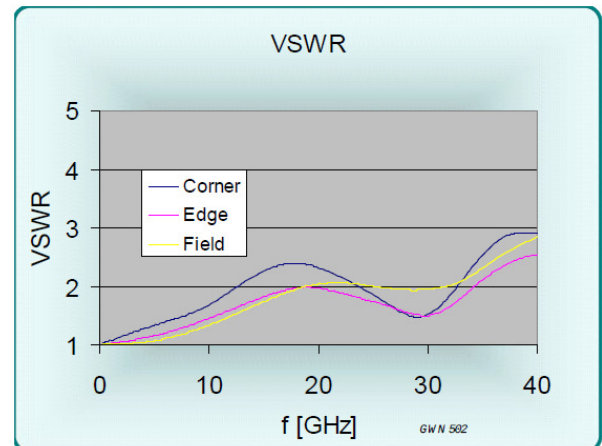

Figure 4: VSWR, D4595-B2

1.0mm (.0394inch) Pitch
EQUIVALENT CIRCUITS / SPICE MODELS

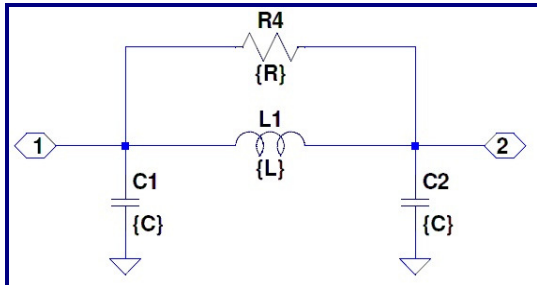

Figure 5: Lumped, Valid to <7GHz

Site	Cg = C1+C2	L1	R4
Corner	0.254 pF	1.34 nH	500 Ω
Edge	0.275 pF	1.11 nH	3000 Ω
Field	0.300 pF	0.98 nH	2000 Ω
Diagonal	0.300 pF	0.98 nH	2000 Ω

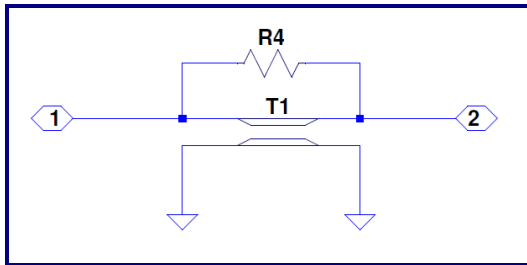

Figure 6: Transmission Line

	Zo	L	R4
Corner	72.7 Ω	18.49 ps	800 Ω
Edge	63.4 Ω	17.47 ps	1500 Ω
Field	57.1 Ω	17.14 ps	2000 Ω

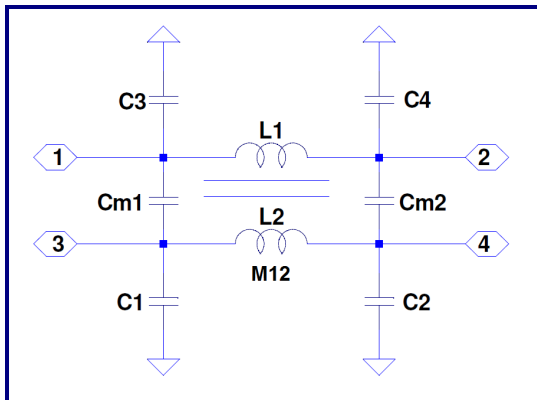

Figure 7: Lumped, Mutual Elements

Site	C1,2,3,4	Cm1,Cm2	L1,L2	M
Corner	0.127	0.031 pF	1.34	0.451 nH
Edge	0.138	0.028 pF	1.11	0.377 nH
Field	0.150	0.023 pF	0.98	0.215 nH
Diagonal	0.150	0.009 pF	0.98	0.105 nH

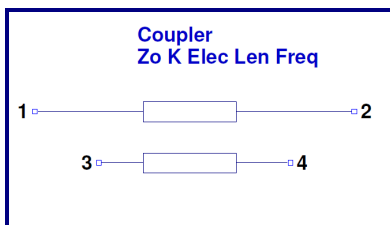
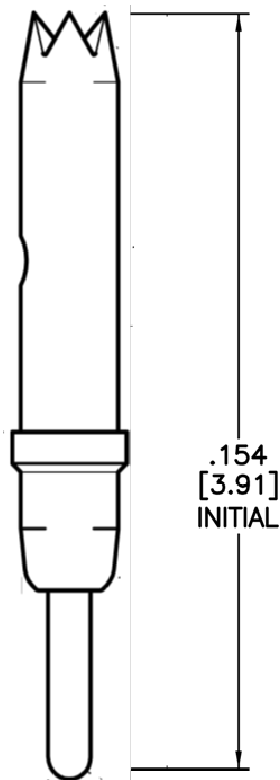

Figure 8: Transmission Line for Crosstalk

Z0	42.8	Ohms
Lel	16.8	ps
k	0.22	
f	29.2	Ghz

D SERIES MODELS

D Series 0.8mm (.0315) pitch									
Probe Series	Initial Length		Operating Position		Spring Force	Self Inductance	Insertion Loss < -1db to	Typical Contact Resistance	Maximum Current
	inch/mm	inch/mm	inch/mm	inch/mm					
D4525	.087"	2.21	.071"	1.80	30 g	0.5 nH	17.0 GHz	20 mOhms	6.0 A
D4565	.092"	2.33	.071"	1.80	30 g	0.5 nH	17.0 GHz	25 mOhms	6.0 A
D4595	.154"	3.91	.128"	3.25	38 g	0.82 nH	19.5 GHz	30 mOhms	3.0 A
D4601	.214"	5.43	.186"	4.72	24-34 g	1.0 nH	12.8 GHz	50 mOhms	6.0 A
D4603	.209"	5.30	.181"	4.59	24 g	1.16 nH	12.4 GHz	70 mOhms	4.0 A
D4613	.249"	6.32	.213-.216"	5.49	24-34 g	1.25 nH	14.3 GHz	40 mOhms	2.15 A
D4623	.289"	7.33	.253"	6.43	34 g	1.55 nH	8.2 GHz	60 mOhms	5.4 A
D4823	.289"	7.33	.253"	6.43	28 g	-	-	-	-
D4693	.185"	4.71	.157"	4.00	24-34 g	0.92 nH	18.3 GHz	40 mOhms	3.0 A
D4694	.185"	4.71	.157"	4.00	23-36 g	0.80 nH	7.8 GHz	40 mOhms	3.0 A
D4697	.339"	8.61	.295"	7.50	32 g	2.01 nH	8.6 GHz	45 mOhms	2.6 A

MECHANICAL DIMENSIONS
 INCHES [MM]

Signal Integrity, Inc.

104 County Street, Ste. 210, Attleboro, MA 02703

 Tel: 1-508-226-6480 Fax: 1-508-226-6488 Internet: www.signalin.com

Signal Integrity makes no representation that the use of its products described herein, or the use of other technical information contained herein, will not infringe on existing or future patent rights. The descriptions contained herein do not imply the granting of licenses to make, use, or sell equipment constructed in accordance therewith. Specifications are subject to change without notice.