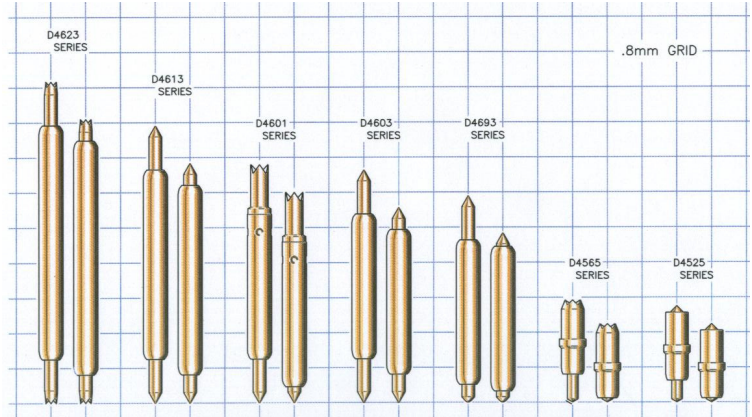

**FEATURES**

- <-1db insertion loss to 14.3 GHz
- <2:1VSWR to 14.94 GHz
- 24g OR 34g operating spring force
- $Z_0 = 32.7$
- <36ps risetime
- 40milliOhms contact resistance
- 2.15 Amps max. drive current

**GENERAL DESCRIPTION**

The D4613 spring probe from Signal Integrity Inc. is designed to meet the rigorous test requirements driven by the ultra fast risetimes in the digital domain, and high bandwidth, high frequency RF / microwave specifications for the wireless market. Along with speed and accuracy, these probes are designed to operate at pitches to 0.8mm, specifically for the fine pitch packaging these markets demand.

The ultra high bandwidth of these probes provides very low insertion loss up to 14.3GHz. These probes will provide transparent operation on Bluetooth, 802.11b and 3G wireless protocol devices as well as exceed the test probe demands of proprietary microwave communications devices and systems.

With an impulse risetime of less than 36.0ps and a propagation delay of 30.9ps, the D4613 has more than enough performance for probe applications and interconnection solutions in broadband digital. These probes are ideal for building transparent test channels or interconnection solutions that must address data communication and source synchronous memory busses. Among others, these include Infiniband, PCI-Express, Source Synchronous DDR, Rambus<sup>™</sup>, HyperTransport and 10Gb Ethernet.

**SERIES D4613 MODELS: ORDERING INFORMATION**

D Series 0.8mm (.03154) Pitch					
Model	Length Operating / initial inch [mm]	DUT Plunger	Interface Plunger	Spring	Operating Spring Force
D4613-A1	.216 [5.49] / .249 [6.32]	Crown - Gold	Conic	Stainless Steel	24 Grams
D4613-B2	.213 [5.41] / .249 [6.32]				34 Grams

**FUNCTIONAL SPECIFICATIONS**

Model	D4613-B2			
Time Domain	Min.	Typ.	Max.	Units
TDT Risetime into 50Ω			36.0	ps
TDR Risetime open circuit			55.5	ps
TDR Risetime short circuit			64.5	ps
Signal Delay into 50Ω		30.9		ps
Frequency Domain				
Insertion Loss <-1db	9.2		14.3	GHz
<-3db	33.08		35.67	GHz
Return Loss, S11 <-10db	10.2			GHz
<-20db	5.4			GHz
VSWR <2:1	5.98		14.94	GHz
Equivalent Circuit Parameters				
Pin Inductance		1.25		nH
Pin Capacitance to ground		0.793		pF
Mutual Inductance		0.215		nH
Mutual Capacitance		0.139		pF
Transmission Line Zo		32.7		Ω
Tl		30.9		ps
DC Parameters				
Contact Resistance		40		mΩ
Maximum Rating				
Drive Current		2.15		A

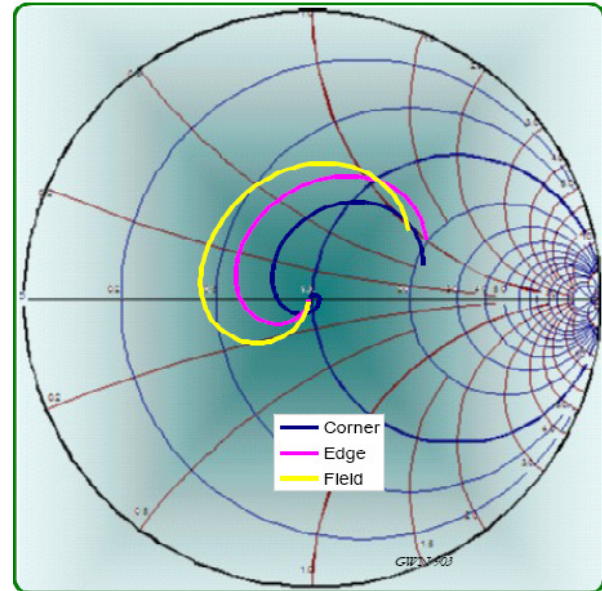

Figure 2: Measurement into 50Ω, D4613-B2

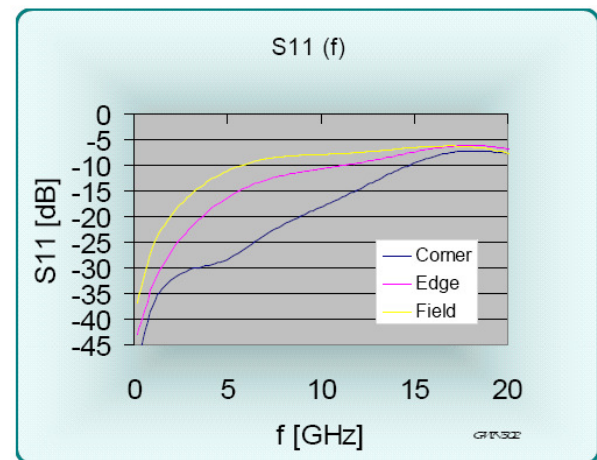

Figure 3: Return Loss, S11, D4613-B2

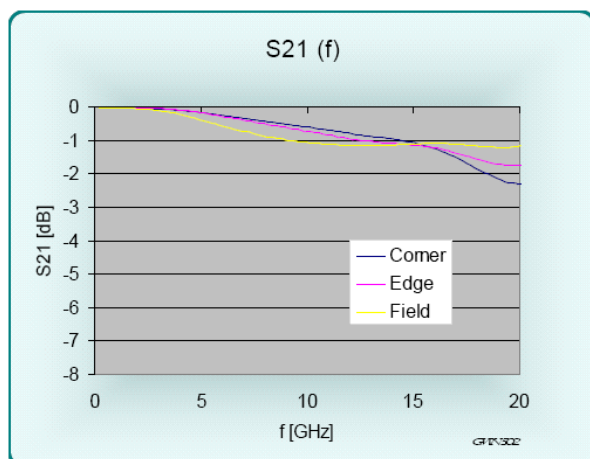

Figure 1: Insertion Loss, S21, D4613-B2

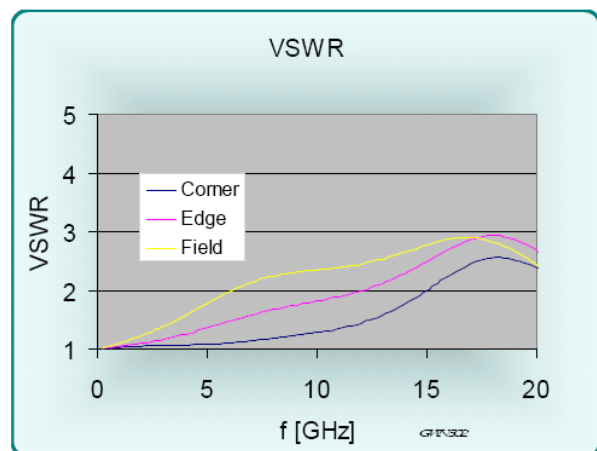

Figure 4: VSWR, D4613-B2

**EQUIVALENT CIRCUITS / SPICE MODELS**

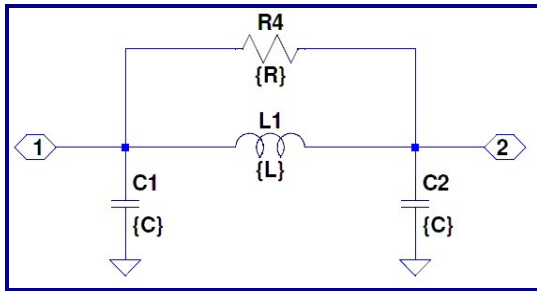

Figure 5: Pi Equivalent, Valid to <7GHz

Site	Cg = C1+C2	L1	R4
Corner	0.622 pF	1.74 nH	1000 $\Omega$
Edge	0.722 pF	1.53 nH	1000 $\Omega$
Field	0.793 pF	1.25 nH	1000 $\Omega$
Diagonal	0.793 pF	1.25 nH	1000 $\Omega$

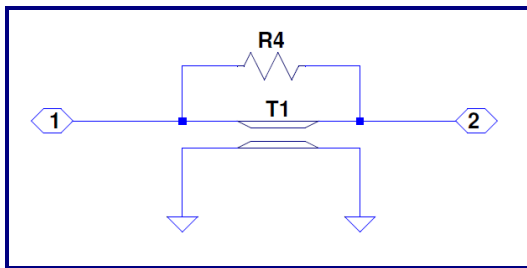

Figure 6: Transmission Line

	Zo	L	R4
Corner	52.9 $\Omega$	32.89 ps	1000 $\Omega$
Edge	46.0 $\Omega$	33.19 ps	1000 $\Omega$
Field	39.7 $\Omega$	31.51 ps	1000 $\Omega$

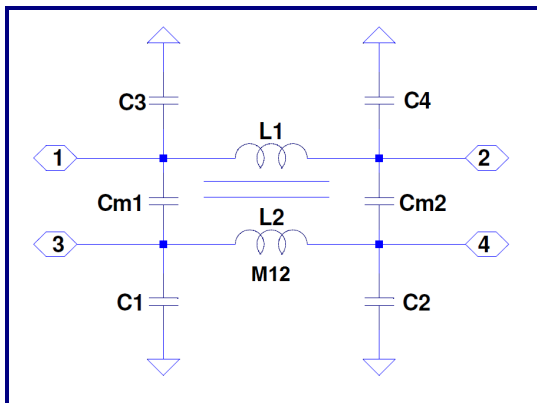

Figure 7: Lumped, Mutual Elements

Site	C1,2,3,4	Cm1,Cm2	L1,L2	M
Corner	0.311	0.104 pF	1.74	0.460 nH
Edge	0.361	0.091 pF	1.53	0.362 nH
Field	0.396	0.069 pF	1.25	0.215 nH
Diagonal	0.396	0.010 pF	1.25	0.057 nH

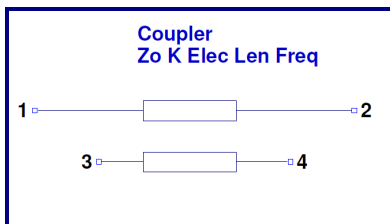
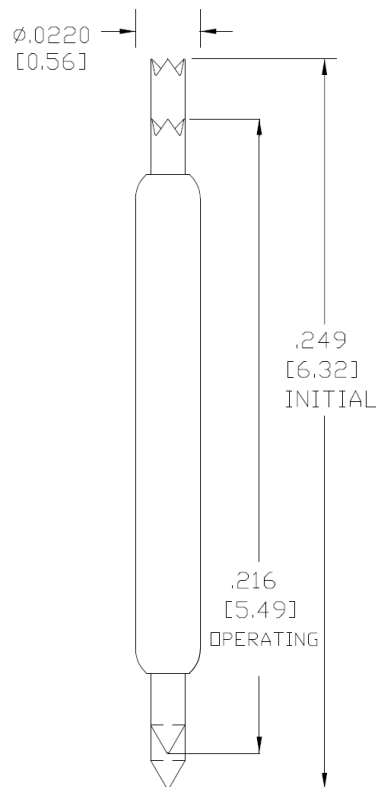

Figure 8: Transmission Line for Crosstalk

Z0	32.7	Ohms
Lel	30.9	ps
k	0.17	
f	16.7	Ghz

D Series 0.8mm (.0315) pitch									
Probe Series	Initial Length		Operating Position		Spring Force	Self Inductance	Insertion Loss < -1db to	Typical Contact Resistance	Maximum Current
	inch/mm	inch/mm	inch/mm	inch/mm					
<a href="#">D4525</a>	.087"	2.21	.071"	1.80	30 g	0.5 nH	17.0 GHz	20 mOhms	6.0 A
D4565	.092"	2.33	.071"	1.80	30 g	0.5 nH	17.0 GHz	25 mOhms	6.0 A
<a href="#">D4595</a>	.154"	3.91	.128"	3.25	38 g	0.82 nH	19.5 GHz	30 mOhms	3.0 A
<a href="#">D4601</a>	.214"	5.43	.186"	4.72	24-34 g	1.0 nH	12.8 GHz	50 mOhms	6.0 A
<a href="#">D4603</a>	.209"	5.30	.181"	4.59	24 g	1.16 nH	12.4 GHz	70 mOhms	4.0 A
<a href="#">D4613</a>	.249"	6.32	.213-.216"	5.49	24-34 g	1.25 nH	14.3 GHz	40 mOhms	2.15 A
<a href="#">D4623</a>	.289"	7.33	.253"	6.43	34 g	1.55 nH	8.2 GHz	60 mOhms	5.4 A
D4823	.289"	7.33	.253"	6.43	28 g	-	-	-	-
<a href="#">D4693</a>	.185"	4.71	.157"	4.00	24-34 g	0.92 nH	18.3 GHz	40 mOhms	3.0 A
<a href="#">D4694</a>	.185"	4.71	.157"	4.00	23-36 g	0.80 nH	7.8 GHz	40 mOhms	3.0 A
<a href="#">D4697</a>	.339"	8.61	.295"	7.50	32 g	2.01 nH	8.6 GHz	45 mOhms	2.6 A

**MECHANICAL DIMENSIONS**  
INCHES [MM]



**Signal Integrity, Inc.**  
 104 County Street, Ste. 210, Attleboro, MA 02703  
 Tel: 1-508-226-6480 Email: [sales@signalin.com](mailto:sales@signalin.com) Internet: [www.signalin.com](http://www.signalin.com)

Signal Integrity makes no representation that the use of its products described herein, or the use of other technical information contained herein, will not infringe on existing or future patent rights. The descriptions contained herein do not imply the granting of licenses to make, use, or sell equipment constructed in accordance therewith. Specifications are subject to change without notice.